



# **MANOPOLE *HANDLES* POIGNEES**



# MVP

## Manopola conica Conical handle

## Poignée conique

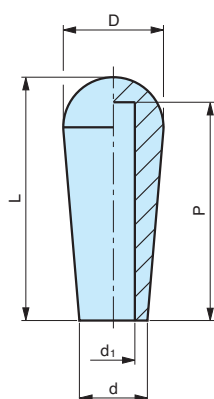

Foro cieco liscio.  
Moulded blind hole.  
Intérieur lisse.

cod.	modello	D	d	d <sub>1</sub>	L	P	peso gr.
7317008	<b>MVP/24x56</b>	24	15	∅ 6	56	50	19,80
7317010	<b>MVP/24x56</b>	24	15	∅ 8	56	50	18,65
7317015	<b>MVP/24x56</b>	24	15	∅10	56	50	17,52
7317020	<b>MVP/24x56</b>	24	15	∅12	56	50	16,00
7317025	<b>MVP/28x68</b>	28	18	∅ 8	68	61	34,00
7317030	<b>MVP/28x68</b>	28	18	∅10	68	61	32,00
7317035	<b>MVP/28x68</b>	28	18	∅12	68	61	30,00
7317040	<b>MVP/28x68</b>	28	18	∅14	68	61	28,00
7317045	<b>MVP/28x68</b>	28	18	∅16	68	61	25,80

**NOTE:** Per quantità adeguate si forniscono in colori diversi.

**Materiale:** PVC nero.  
Black PVC.  
PVC noir.

MISURE NON IMPEGNATIVE

# MVP

## Manopola conica Conical handle

## Poignée conique

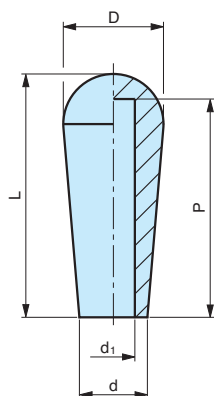

Foro cieco liscio.  
Moulded blind hole.  
Intérieur lisse.

cod.	modello	D	d	d <sub>1</sub>	L	P	peso gr.
7317830	<b>MVP/20x43</b>	20	13	∅ 6	43	38	10,50
7317835	<b>MVP/20x43</b>	20	13	∅ 7	43	38	9,65
7317840	<b>MVP/20x43</b>	20	13	∅ 8	43	38	9,80
7317845	<b>MVP/20x43</b>	20	13	∅10	43	38	9,00
7317855	<b>MVP/20x43</b>	20	13	∅12	43	38	8,00

**NOTE:** Per quantità adeguate si forniscono in colori diversi.

**Materiale:** PVC nero.  
Black PVC.  
PVC noir.

MISURE NON IMPEGNATIVE

# MVP

## Manopola cilindrica Cylindrical handle

## Poignée cylindrique

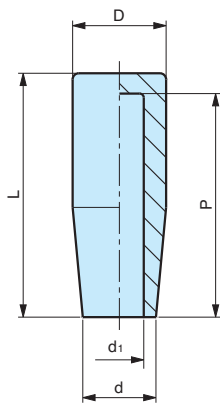

Foro cieco liscio.  
Moulded blind hole.  
Intérieur lisse.

cod.	modello	D	d	d <sub>1</sub>	L	P	peso gr.
7317865	<b>MVP/23x60</b>	23	18	∅ 7	60	55	24,14
7317870	<b>MVP/23x60</b>	23	18	∅ 8	60	55	23,00
7317875	<b>MVP/23x60</b>	23	18	∅ 9	60	55	23,00
7317880	<b>MVP/23x60</b>	23	18	∅10	60	55	22,00
7317885	<b>MVP/23x60</b>	23	18	∅11	60	55	22,00
7317890	<b>MVP/23x60</b>	23	18	∅12	60	55	21,00
7317900	<b>MVP/23x60</b>	23	18	∅14	60	55	20,00

**NOTE:** Per quantità adeguate si forniscono in colori diversi.

**Materiale:** PVC nero.  
Black PVC.  
PVC noir.

MISURE NON IMPEGNATIVE

# MVP

## Manopola Handle

## Poignée conique

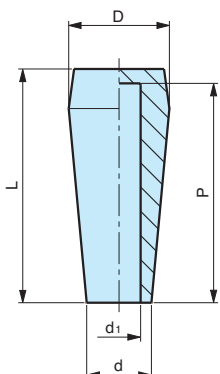

Foro cieco liscio.  
Moulded blind hole.  
Intérieur lisse.

cod.	modello	D	d	d <sub>1</sub>	L	P	peso gr.
7317048	<b>MVP/24x53</b>	24	15	∅ 6	53	50	21,30
7317050	<b>MVP/24x53</b>	24	15	∅ 8	53	50	20,40
7317055	<b>MVP/24x53</b>	24	15	∅10	53	50	18,43
7317060	<b>MVP/24x53</b>	24	15	∅12	53	50	19,00
7317065	<b>MVP/28x65</b>	28	18	∅ 8	65	61	23,70
7317070	<b>MVP/28x65</b>	28	18	∅10	65	61	22,30
7317075	<b>MVP/28x65</b>	28	18	∅12	65	61	20,90
7317080	<b>MVP/28x65</b>	28	18	∅14	65	61	19,50
7317085	<b>MVP/28x65</b>	28	18	∅16	65	61	18,10

**NOTE:** Per quantità adeguate si forniscono in colori diversi.

**Materiale:** PVC nero.  
Black PVC.  
PVC noir.

MISURE NON IMPEGNATIVE

# MVP

## Manopola Handle

## Poignée

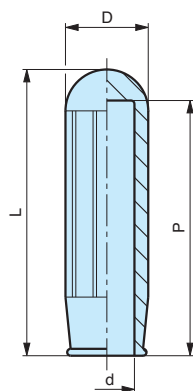

Foro cieco liscio.  
Moulded blind hole.  
Intérieur lisse.

cod.	modello	D	d	L	P	peso gr.
7317092	<b>MVP/24x83</b>	24	∅10	83	78	35,00
7317095	<b>MVP/24x83</b>	24	∅12	83	78	33,76
7317100	<b>MVP/24x83</b>	24	∅14	83	78	32,00
7317105	<b>MVP/24x83</b>	24	∅16	83	78	26,40
7317110	<b>MVP/24x83</b>	24	∅18	83	78	24,64
7317115	<b>MVP/24x83</b>	24	∅20	83	78	19,11

**NOTE:** Per quantità adeguate si forniscono in colori diversi.

**Materiale:** PVC nero.  
Black PVC.  
PVC noir.

MISURE NON IMPEGNATIVE

# MVP

## Manopola conica Conical handle

## Poignée conique

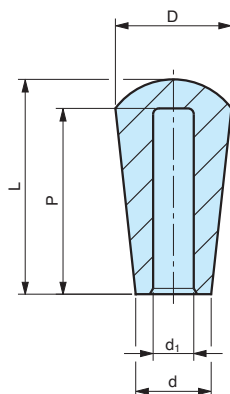

Foro cieco liscio.  
Moulded blind hole.  
Intérieur lisse.

cod.	modello	D	d	d <sub>1</sub>	L	P	peso gr.
7317005	<b>MVP/20x37</b>	20	∅8	8	37	34	20,40

**NOTE:** Per quantità adeguate si forniscono in colori diversi.

**Materiale:** PVC nero.  
Black PVC.  
PVC noir.

MISURE NON IMPEGNATIVE

# PVZ

## Manopola zigrinata Knurled handle

## Poignée

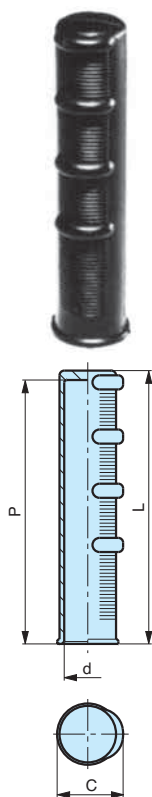

Foro cieco liscio.  
Moulded blind hole.  
Intérieur lisse.

cod.	modello	L	d	C	P	peso gr.
7317342	<b>PVZ/27x116</b>	116	Ø12	27	112	36,00
7317343	<b>PVZ/27x116</b>	116	Ø14	27	112	45,00
7317345	<b>PVZ/27x116</b>	116	Ø16	27	112	40,00
7317350	<b>PVZ/27x116</b>	116	Ø18	27	112	35,00
7317355	<b>PVZ/27x116</b>	116	Ø20	27	112	27,70
7317360	<b>PVZ/27x116</b>	116	Ø21	27	112	26,00
7317365	<b>PVZ/27x116</b>	116	Ø22	27	112	26,00
7317370	<b>PVZ/27x116</b>	116	Ø22L	27	112	23,00

**NOTE:** Per quantità adeguate si forniscono in colori diversi.

**Materiale:** PVC nero.  
Black PVC.  
PVC noir.

MISURE NON IMPEGNATIVE

# PVZ

## Manopola zigrinata Knurled handle

## Poignée

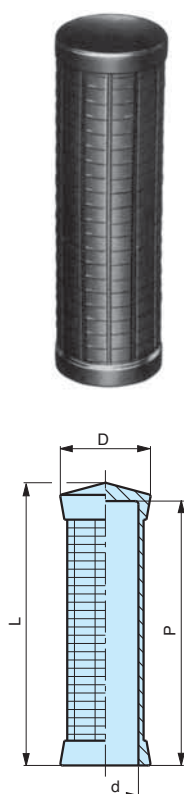

Foro cieco liscio.  
Moulded blind hole.  
Intérieur lisse.

cod.	modello	L	d	D	P	peso gr.
7317210	<b>PVZ/40x137</b>	137	Ø27	43	131	95,00
7317215	<b>PVZ/40x137</b>	137	Ø33	43	131	65,00

Antivibrante

**NOTE:** Per quantità adeguate si forniscono in colori diversi.

**Materiale:** PVC nero.  
Black PVC.  
PVC noir.

MISURE NON IMPEGNATIVE

# PVZ

## Manopola zigrinata Knurled handle

## Poignée

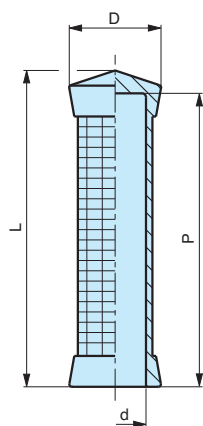

Foro cieco liscio.  
Moulded blind hole.  
Intérieur lisse.

cod.	modello	L	d	D	P	peso gr.
7317125	<b>PVZ/33x123</b>	123	Ø20	35	118	53,00
7317130	<b>PVZ/33x123</b>	123	Ø21-22	35	118	70,00
7317135	<b>PVZ/33x123</b>	123	Ø24-25	35	118	34,00
7317140	<b>PVZ/33x123</b>	123	Ø25-27	35	118	52,00
7317150	<b>PVZ/33x123</b>	123	Ø27-28	35	118	54,00

**NOTE:** Per quantità adeguate si forniscono in colori diversi.

**Materiale:** PVC nero.  
Black PVC.  
PVC noir.

MISURE NON IMPEGNATIVE

# PVZ

## Manopola zigrinata con paramano Knurled handle with hand gard

## Poignée à collerette

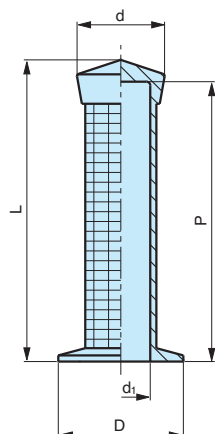

Foro cieco liscio.  
Moulded blind hole.  
Intérieur lisse.

cod.	modello	L	d <sub>1</sub>	d	D	P	peso gr.
7317160	<b>PVZ/51x123</b>	123	Ø20	35	51	118	89,44
7317165	<b>PVZ/51x123</b>	123	Ø21-22	35	51	118	75,90
7317170	<b>PVZ/51x123</b>	123	Ø24-25	35	51	118	64,00
7317175	<b>PVZ/51x123</b>	123	Ø25-27	35	51	118	58,00
7317185	<b>PVZ/51x123</b>	123	Ø27-28	35	51	118	47,73

**NOTE:** Per quantità adeguate si forniscono in colori diversi.

**Materiale:** PVC nero.  
Black PVC.  
PVC noir.

MISURE NON IMPEGNATIVE

# PVZ

## Manopola zigrinata Knurled handle

## Poignée

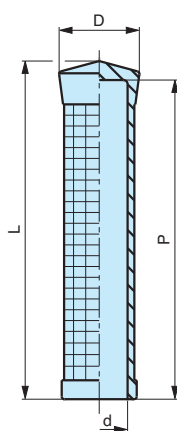

Foro cieco liscio.  
Moulded blind hole.  
Intérieur lisse.

cod.	modello	L	d	D	P	peso gr.
7317407	PVZ/30x125	125	Ø16	30	120	64,00
7317409	PVZ/30x125	125	Ø18	30	120	53,14
7317410	PVZ/30x125	125	Ø19	30	120	55,00
7317415	PVZ/30x125	125	Ø20-21	30	120	51,00
7317420	PVZ/30x125	125	Ø21-22	30	120	41,00
7317430	PVZ/30x125	125	Ø24-25	30	120	29,00

**NOTE:** Per quantità adeguate si forniscono in colori diversi.

**Materiale:** PVC nero.  
Black PVC.  
PVC noir.

MISURE NON IMPEGNATIVE

# PVZ

## Manopola zigrinata con paramano Knurled handle with hand gard

## Poignée à collerette

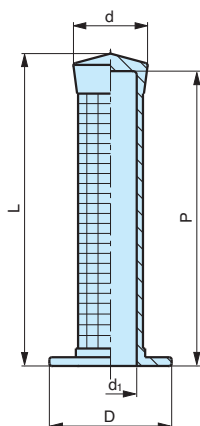

Foro cieco liscio.  
Moulded blind hole.  
Intérieur lisse.

cod.	modello	L	d <sub>1</sub>	d	D	P	peso gr.
7317432	PVZ/49x125	125	Ø16	30	49	120	69,00
7317434	PVZ/49x125	125	Ø18	30	49	120	64,00
7317440	PVZ/49x125	125	Ø20-21	30	49	120	54,26
7317445	PVZ/49x125	125	Ø21-22	30	49	120	50,00
7317450	PVZ/49x125	125	Ø24-25	30	49	120	34,00

**NOTE:** Per quantità adeguate si forniscono in colori diversi.

**Materiale:** PVC nero.  
Black PVC.  
PVC noir.

MISURE NON IMPEGNATIVE

# PV

## Manopola Handle

## Poignée

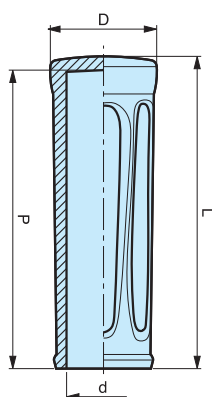

Foro cieco liscio.  
Moulded blind hole.  
Intérieur lisse.

cod.	modello	L	d	D	P	peso gr.
7317740	<b>PV/31x115</b>	115	Ø18-19	31	110	58,00
7317742	<b>PV/31x115</b>	115	Ø20-21	31	110	52,00
7317744	<b>PV/31x115</b>	115	Ø22-23	31	110	42,00
7317750	<b>PV/36x125</b>	125	Ø24-25	36	120	68,00
7317752	<b>PV/36x125</b>	125	Ø26	36	120	56,00
7317754	<b>PV/36x125</b>	125	Ø27-28	36	120	44,00
7317755	<b>PV/36x125</b>	125	Ø29	36	120	44,00
7317760	<b>PV/42x130</b>	130	Ø30	42	125	84,00
7317765	<b>PV/42x130</b>	130	Ø33	42	125	66,00

**NOTE:** Per quantità adeguate si forniscono in colori diversi.

**Materiale:** PVC nero.  
Black PVC.  
PVC noir.

MISURE NON IMPEGNATIVE

# PV

## Manopola con paramano Handle with hand gard

## Poignée à colerette

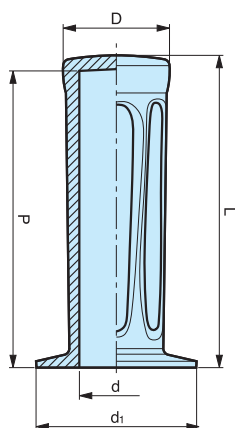

Foro cieco liscio.  
Moulded blind hole.  
Intérieur lisse.

cod.	modello	L	d	d <sub>1</sub>	D	P	peso gr.
7317770	<b>PV/44x115</b>	115	Ø18-19	31	44	110	62,00
7317772	<b>PV/44x115</b>	115	Ø20-21	31	44	110	56,00
7317774	<b>PV/44x115</b>	115	Ø22-23	31	44	110	46,00
7317780	<b>PV/49x125</b>	125	Ø24-25	36	49	120	72,00
7317782	<b>PV/49x125</b>	125	Ø26	36	49	120	60,00
7317784	<b>PV/49x125</b>	125	Ø27-28	36	49	120	50,00
7317785	<b>PV/49x125</b>	125	Ø29	36	49	120	50,00
7317790	<b>PV/51x130</b>	130	Ø30	42	51	125	92,00
7317795	<b>PV/51x130</b>	130	Ø33	42	51	125	74,00

**NOTE:** Per quantità adeguate si forniscono in colori diversi.

**Materiale:** PVC nero.  
Black PVC.  
PVC noir.

MISURE NON IMPEGNATIVE



# MPV

## Manopola piatta Flat handle

## Poignée pour méplat

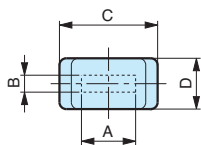
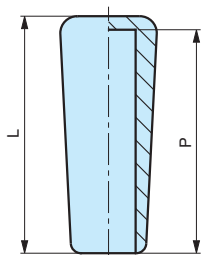

Foro cieco liscio.  
Moulded blind hole.  
Intérieur lisse.

cod.	modello	L	AxB	C	D	P	peso gr.
7317230	MPV/29x70	70	15x 4	29	14	66	23,56
7317235	MPV/29x70	70	15x 5	29	14	66	22,00
7317240	MPV/29x70	70	15x 6	29	14	66	22,00
7317245	MPV/29x70	70	15x 8	29	14	66	20,00
7317253	MPV/29x70	70	20x 4	29	14	66	20,10
7317255	MPV/29x70	70	20x 5	29	14	66	20,10
7317260	MPV/29x70	70	20x 6	29	14	66	20,10
7317265	MPV/29x70	70	20x 8	29	14	66	20,00

**NOTE:** Per quantità adeguate si forniscono in colori diversi.

**Materiale:** PVC nero.  
Black PVC.  
PVC noir.

MISURE NON IMPEGNATIVE

# MPV

## Manopola piatta Flat handle

## Poignée pour méplat

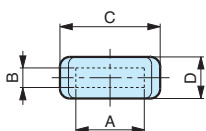
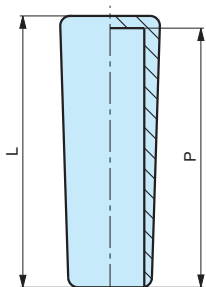

Foro cieco liscio.  
Moulded blind hole.  
Intérieur lisse.

cod.	modello	L	AxB	C	D	P	peso gr.
7317275	MPV/41x111	111	25x 6	41	16,5	108	60,00
7317280	MPV/41x111	111	25x 8	41	16,5	108	60,00
7317290	MPV/41x111	111	30x 5	41	16,5	108	55,00
7317295	MPV/41x111	111	30x 6	41	16,5	108	55,00
7317300	MPV/41x111	111	30x 8	41	16,5	108	50,25

**NOTE:** Per quantità adeguate si forniscono in colori diversi.

**Materiale:** PVC nero.  
Black PVC.  
PVC noir.

MISURE NON IMPEGNATIVE

# MPV

## Manopola piatta Flat handle

## Poignée pour méplat

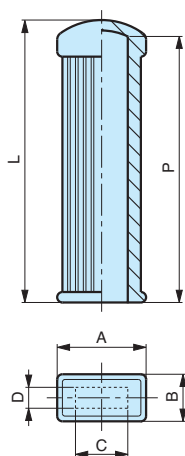

Foro cieco liscio.  
Moulded blind hole.  
Intérieur lisse.

cod.	modello	L	A	B	CxD	P	peso gr.
7317310	<b>MPV/34x108</b>	108	34	18	20x 6	105	52,00
7317320	<b>MPV/34x108</b>	108	34	18	20x 8	105	47,00
7317335	<b>MPV/34x108</b>	108	34	18	25x 8	105	43,00
7317340	<b>MPV/34x108</b>	108	34	18	25x10	105	40,00

**NOTE:** Per quantità adeguate si forniscono in colori diversi.

**Materiale:** PVC nero.  
Black PVC.  
PVC noir.

MISURE NON IMPEGNATIVE

# MPV

## Manopola piatta Flat handle

## Poignée pour méplat

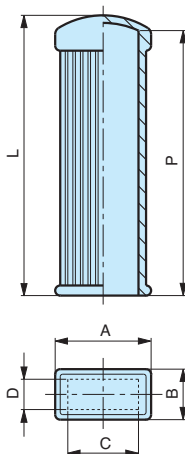

Foro cieco liscio.  
Moulded blind hole.  
Intérieur lisse.

cod.	modello	L	A	B	CxD	P	peso gr.
7317390	<b>MPV/38x111</b>	111	38	20	30x12	108	38,00
7317395	<b>MPV/38x111</b>	111	38	20	30x15	108	38,00
7317397	<b>MPV/38x111</b>	111	38	20	32x12	108	-

**NOTE:** Per quantità adeguate si forniscono in colori diversi.

**Materiale:** PVC nero.  
Black PVC.  
PVC noir.

MISURE NON IMPEGNATIVE

# MPV

## Manopola piatta Flat handle

## Poignée pour méplat

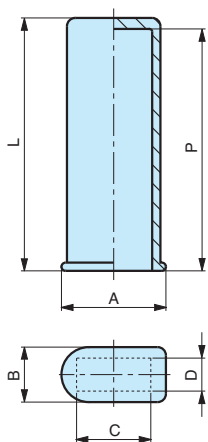

Foro cieco liscio.  
Moulded blind hole.  
Intérieur lisse.

cod.	modello	L	A	B	CxD	P	peso gr.
7317400	<b>MPV/38x92</b>	92	38	20	30x10	87	31,00
7317405	<b>MPV/38x92</b>	92	38	20	30x12	87	31,00

**NOTE:** Per quantità adeguate si forniscono in colori diversi.

**Materiale:** PVC nero.  
Black PVC.  
PVC noir.

MISURE NON IMPEGNATIVE

# MPV

## Manopola piatta Flat handle

## Poignée pour méplat

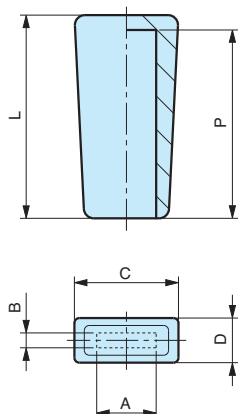

Foro cieco liscio.  
Moulded blind hole.  
Intérieur lisse.

cod.	modello	L	C	D	AxB	P	peso gr.
7317376	<b>MPV/21x41</b>	41	21	9	13x3	39	6,00

**NOTE:** Per quantità adeguate si forniscono in colori diversi.

**Materiale:** PVC nero.  
Black PVC.  
PVC noir.

MISURE NON IMPEGNATIVE

# MPV

## Manopola piatta Flat handle

## Poignée pour méplat

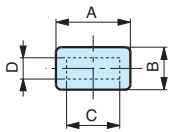
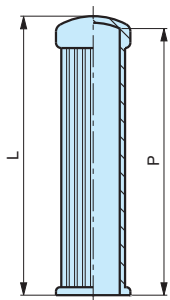

Foro cieco liscio.  
Moulded blind hole.  
Intérieur lisse.

cod.	modello	L	A	B	CxD	P	peso gr.
7317470	<b>MPV/28x105</b>	105	28	16	20x6	101	33,12

**NOTE:** Per quantità adeguate si forniscono in colori diversi.

**Materiale:** PVC nero.  
Black PVC.  
PVC noir.

MISURE NON IMPEGNATIVE

# MPV

## Manopola piatta Flat handle

## Poignée pour méplat

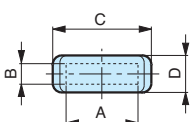
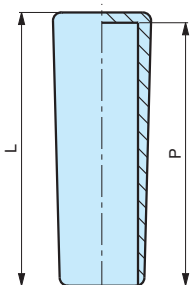

Foro cieco liscio.  
Moulded blind hole.  
Intérieur lisse.

cod.	modello	L	AxB	C	D	P	peso gr.
7317600	<b>MPV/48x133</b>	133	35x10	48	18	127	70,00
7317605	<b>MPV/48x133</b>	133	35x12	48	18	127	68,00

**NOTE:** Per quantità adeguate si forniscono in colori diversi.

**Materiale:** PVC nero.  
Black PVC.  
PVC noir.

MISURE NON IMPEGNATIVE

# TG

Tirante  
Clamping handle

Attache capot



cod.	modello	L	A	B	D	d <sub>1</sub>	d	peso gr.
7317485	TG/153	148	53	24	20	26	∅4	57,00

**NOTE:** A richiesta si forniscono anche in gomma caricata 30% DUTRAL, durezza 60 SHORE~.  
Da usare con ganci tipo A-B-C di pagina 13 forniti a parte su richiesta.

**Materiale:** Gomma nera, durezza 65/70 SHORE~.  
Black rubber, 65/70 SHORE~.  
Caoutchouc noir.

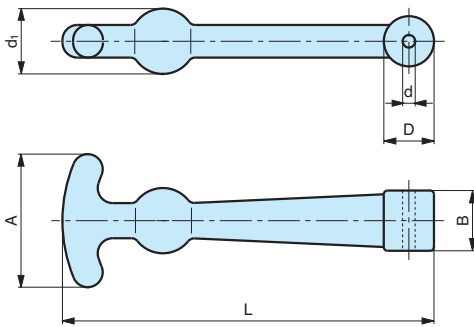

MISURE NON IMPEGNATIVE

# TG

Tirante  
Clamping handle

Attache capot



cod.	modello	L	A	B	C	D	d	d <sub>1</sub>	peso gr.
7317505	TG/120	120	58	28	32	20	∅5	25	41,60

**NOTE:** A richiesta si forniscono anche in gomma caricata DUTRAL, durezza 60 SHORE~.  
Da usare con ganci tipo A-B-D di pagina 13 forniti a parte su richiesta.

**Materiale:** Gomma nera, durezza 65/70 SHORE~.  
Black rubber, 65/70 SHORE~.  
Caoutchouc noir.

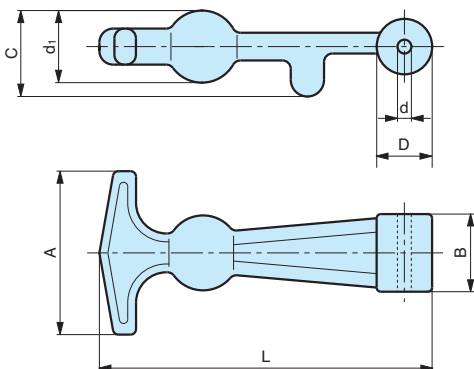

MISURE NON IMPEGNATIVE

# TRI

## Tirante Clamping handle

## Attache capot

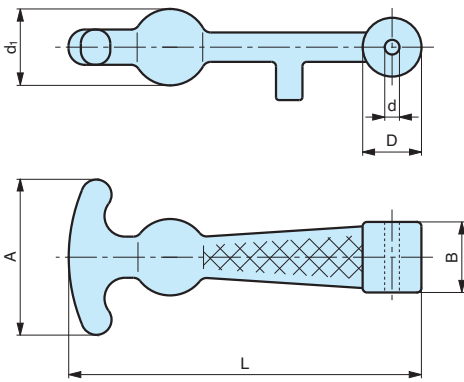

cod.	modello	L	A	B	D	d <sub>1</sub>	d	peso gr.
7317525	TRI/120	120	54	25	19	25	∅4	41,10

**NOTE:** A richiesta si forniscono anche in gomma caricata DUTRAL, durezza 60 SHORE~.  
Da usare con ganci tipo A-B-C di pagina 13 forniti a parte su richiesta.

**Materiale:** Gomma nera, durezza 65/70 SHORE~.  
Black rubber, 65/70 SHORE~.  
Caoutchouc noir.

MISURE NON IMPEGNATIVE

# GANCI - HOOKS - ATTACHE

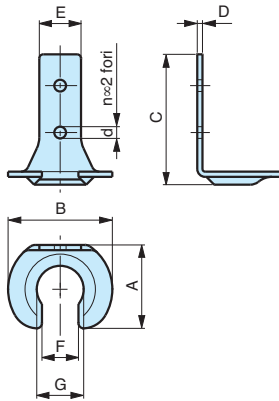

cod.	modello	A	B	C	D	E	d	F	G	peso gr.
7317490	<b>A/32</b>	32	40	50	2	16	∅4	15	18	21,22 grezzo
7317510	<b>AZ/32</b>	32	40	50	2	16	∅4	15	18	21,22 zincato

**NOTE:** A richiesta possiamo fornire la copiglia e/o il chiodino con rondella, in ferro zincato.

**Materiale:** Ferro.  
Iron.  
Fer.

MISURE NON IMPEGNATIVE

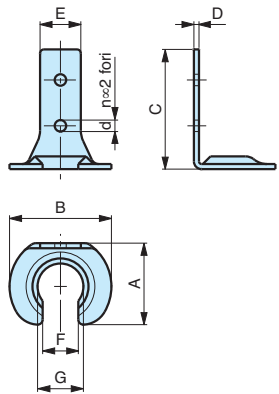

cod.	modello	A	B	C	D	E	d	F	G	peso gr.
7317495	<b>B/32</b>	32	38	44	2	16	∅4	15	18	21,22 grezzo
7317515	<b>BZ/32</b>	32	38	44	2	16	∅4	15	18	21,22 zincato

**NOTE:** A richiesta possiamo fornire la copiglia e/o il chiodino con rondella, in ferro zincato.

**Materiale:** Ferro.  
Iron.  
Fer.

MISURE NON IMPEGNATIVE

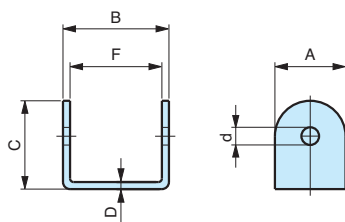

cod.	modello	A	B	C	D	d	F	peso gr.
7317500	<b>C/25</b>	20	30	25	2	∅5	26	21,22 grezzo

**Materiale:** Ferro.  
Iron.  
Fer.

MISURE NON IMPEGNATIVE

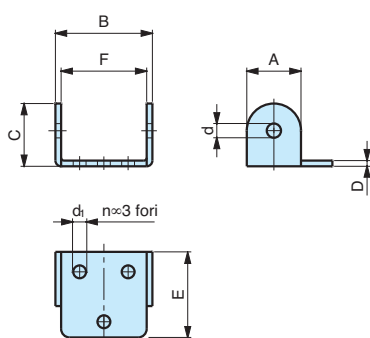

cod.	modello	A	B	C	D	E	F	d	d <sub>1</sub>	peso gr.
7317520	<b>D/23</b>	19	34	22	2	30	30	∅5	∅4	22,22 grezzo
7317560	<b>DZ/23</b>	19	34	22	2	30	30	∅5	∅4	22,22 zincato

**NOTE:** A richiesta possiamo fornire la copiglia e/o il chiodino con rondella, in ferro zincato.

**Materiale:** Ferro.  
Iron.  
Fer.

MISURE NON IMPEGNATIVE

